

**206-MAS3-**  
Lavatory Angle Stop Kit  
1/2" Sweat x 3/8" OD Compression

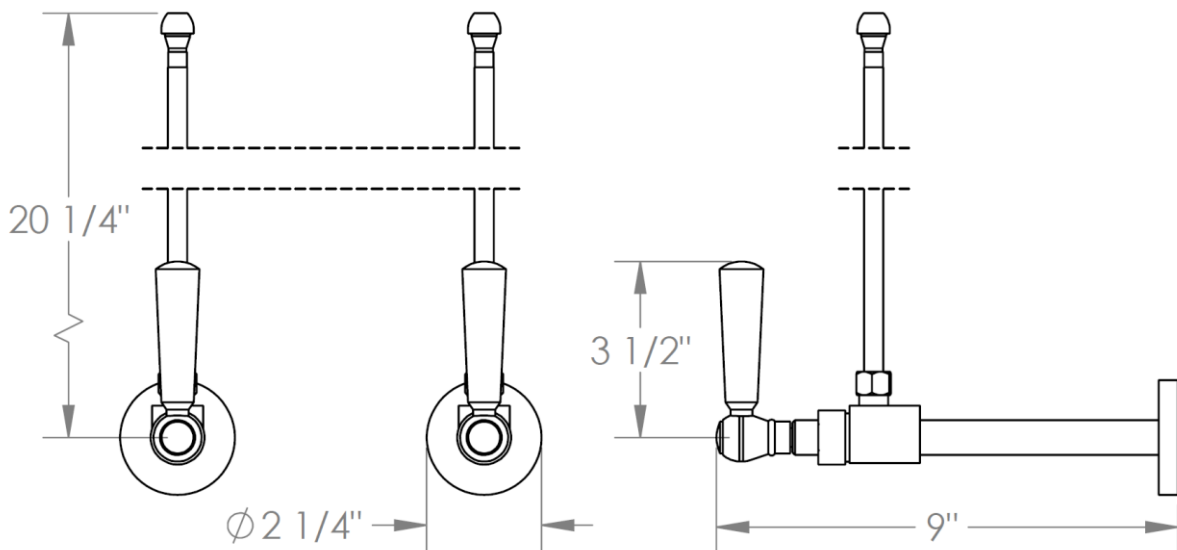

HANDLE TRIM OPTIONS

S1 - PRESTON

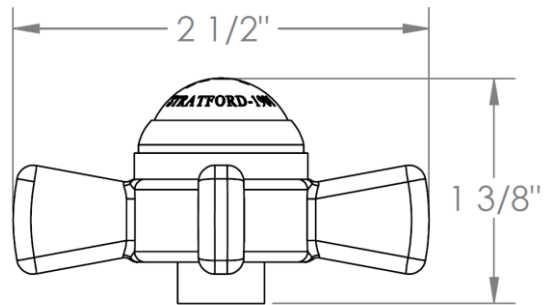

S2 - WALTHAM

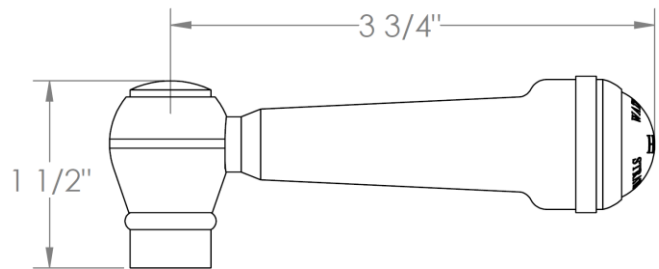

SWA - DARIEN

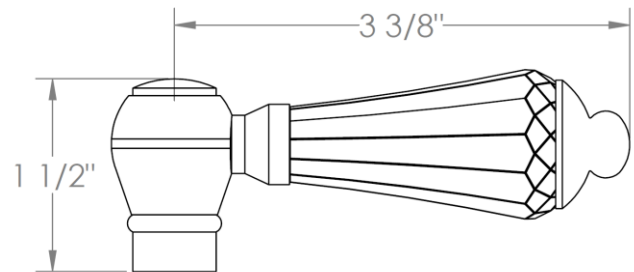

V - WALES

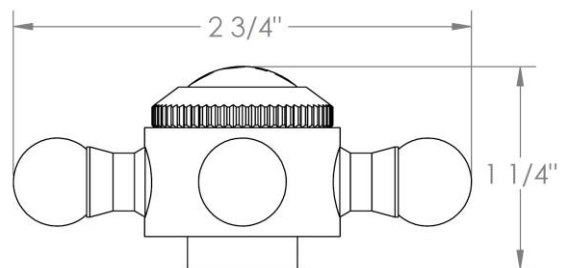

S1A – NOTTINGHAM

