

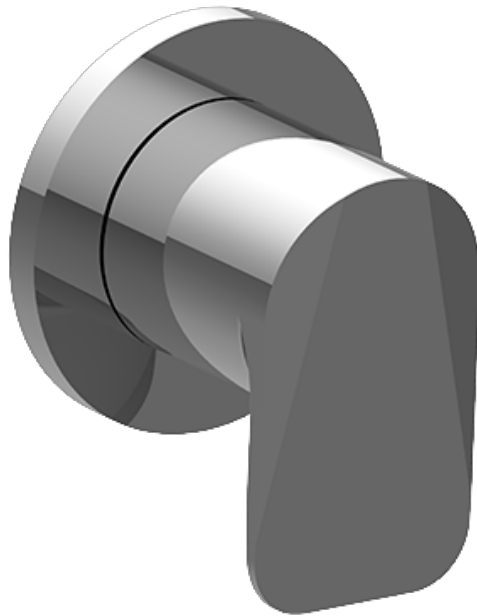















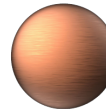

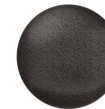
SHOWER
M-Series 2-Way Diverter Valve
Trim with Handle
G-8068-LM59E1-T



Information

- Single metal handle
- Decorative trim plate
- Use with G-8052 2-Way Diverter Volume Control Valve WITH Off Function and Pass-Through
- ADA

Finishes

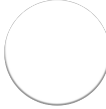
							
24K Gold	24K Brushed Gold	Brushed Brass PVD	Architectural Black™	Brushed Onyx PVD®	Brushed OR'osa PVD®	Gunmetal	Gunmetal Distressed
							
Matte Black	Olive Bronze	Onyx PVD®	Polished Brass PVD	Polished Chrome	Polished Nickel	OR'osa PVD®	Steelnox® (Satin Nickel)
							
Unfinished Brass	Unfinished Brushed Brass	Architectural White					

G-8068-LM59E1-T

Sento Series

