



# OWNER'S MANUAL & INSTALLATION GUIDE

## Estate Air-Whirlpool

**INSTALLER: This booklet must be given to the product owner.**

Read all instructions before proceeding. All specifications are  $\pm 3/8''$  and are subject to change without notice. Dimensions listed in inches.

**Model #** \_\_\_\_\_

**Purchase Date** \_\_\_\_\_

**Serial #** \_\_\_\_\_

**Distributor** \_\_\_\_\_



## TABLE OF CONTENTS

<b>PRODUCT WARRANTY REGISTRATION INFORMATION</b>	3
<b>INSTRUCTIONS PERTAINING TO A RISK OF FIRE, ELECTRIC SHOCK, OR INJURY TO PERSONS</b>	4 – 5
<b>USER INFORMATION</b>	6
<b>FCC INFORMATION</b>	6
<b>AQUATIC LIMITED LIFETIME WARRANTY</b>	7
<b>INSTALLATION INSTRUCTIONS</b>	
Pre-Installation Procedures	8
Structural Preparation	9 – 10
Factory Installed Tile Flange	10
Integrally Skirted Models	10 – 11
Framing Diagrams	12
Deck Cutouts	13
Plumbing	14
Electrical Installation	14 – 15
Final System Test & Clean-Up	16
<b>OPERATION</b>	
Bathside Control Systems	17 – 18
Jet Operations	19
To Replace LED Light	20
<b>TUB CARE</b>	
Maintenance	21 – 22
Repair	22
<b>WATER QUALITY</b>	
Chemical and Water Quality	23 – 24
<b>TROUBLESHOOTING GUIDE</b>	25
<b>REPLACEMENT PARTS LIST</b>	26
<b>REPLACEMENT PARTS MAP</b>	27 – 28

## AQUATIC

# Product Warranty Registration Information

Thank you for choosing an Aquatic bath. You have chosen one of the finest bath products in the industry! Aquatic supports your purchase with strong commitments to quality and customer satisfaction.

### IMPORTANT!

To activate Product Warranty please register with Aquatic. Your product warranty must be registered and confirmed with Aquatic through the Serial Number on your unit. To register, please contact Aquatic.

(800) 945-2726 • [www.aquaticbath.com/register](http://www.aquaticbath.com/register)

Please read and follow all of the instructions contained in this Owner's Manual before installing, operating or maintaining your bath. In addition, you should continually refer to these instructions during the life of your air-whirlpool bath. Failure to comply with these instructions may invalidate your warranty. If you have any questions concerning installation, operation, maintenance or any other aspect of your Aquatic bath, please contact:

**AQUATIC CUSTOMER SERVICE CENTER: (800) 945-2726**

(The Troubleshooting Guide on page 25 may be helpful in answering some of your questions.)

**NOTE:** The installation and service of your air-whirlpool should be performed **ONLY** by a qualified electrician and plumber.

### IMPORTANT!

This product **MUST BE WATER-TESTED** and inspected prior to installation or warranty will be voided. See page 8 for instructions.

**PLEASE CHECK ENTIRE UNIT FOR ANY DAMAGE.**

If it appears damaged, contact your Aquatic Distributor immediately. Aquatic warranty does not cover damage that occurs in transit.

#### MODEL & SERIAL NUMBER LOCATION

The tub model and serial numbers are located above the pump area on the backside of the bathtub. An access panel should be placed by the installer at this location.



# AQUATIC

The bath people



# INSTRUCTIONS PERTAINING TO A RISK OF FIRE, ELECTRIC SHOCK, OR INJURY TO PERSONS

**WARNING:** When using this unit, basic precautions should always be followed. Failure to follow these instructions could result in personal injury, electric shock, or fire.

## READ AND FOLLOW ALL INSTRUCTIONS:

- **WARNING:** Risk of lethal electric shock. To reduce risk of electric shock, connect only to circuits protected by a Ground-Fault Circuit-Interrupter (GFCI) or Residual Current Device (RCD).
- **DANGER:** To reduce the risk of injury, do not permit children to use this unit unless they are closely supervised at all times.
- Use this unit only for its intended use as described in this manual. Do not use additional attachments and/or equipment not recommended by the manufacturer.
- Never drop or insert any object into any opening.
- The unit must be connected only to a supply circuit that is protected by a Ground-Fault Circuit-Interrupter (GFCI). Such a GFCI should be provided by the installer and should be tested on a routine basis. To test the GFCI, push the test button. The GFCI should interrupt power. Push the reset button. Power should be restored. If the GFCI fails to operate in this manner, there is a ground current flowing, indicating the possibility of an electric shock. Do not use this unit. Disconnect the unit and have the problem corrected by a qualified service representative before using.
- To reduce the risk of injury, enter and exit the bath slowly.
- This product is intended for indoor use only. Installing this unit outdoors could cause personal injury and will void your warranty.

SAVE THESE INSTRUCTIONS.

**CALIFORNIA PROP. 65**



**WARNING:** This product can expose you to chemicals including styrene and styrene compounds, which are known to the State of California to cause cancer and birth defects or other reproductive harm. For more information go to [www.p65warnings.ca.gov](http://www.p65warnings.ca.gov)

**! WARNING**



**Electrical Shock Hazard**

Plug into a grounded 3-prong outlet.

Do not remove ground prong.

Do not use an adapter.

Do not use an extension cord.

Failure to follow these instructions can result in death, fire, or electrical shock.

**Your safety and the safety of others are very important.**

We have provided many important safety messages in this manual and on your appliance. Always read and obey all safety messages.



This is the safety alert symbol. This symbol alerts you to potential hazards that can kill or hurt you and others.

All safety messages will follow the safety alert symbol and either the word "DANGER" or "WARNING." These words mean:

**! DANGER**

You can be killed or seriously injured if you don't immediately follow instructions.

**! WARNING**

All safety messages will tell you what the potential hazard is, tell you how to reduce the chance of injury, and tell you what can happen if the instructions are not followed.

# INSTRUCTIONS PERTAINING TO A RISK OF FIRE, ELECTRIC SHOCK, OR INJURY TO PERSONS

Before taking your first air-whirlpool bath, be sure that you are familiar with all the controls and switches [See **BATHSIDE CONTROL SYSTEMS** starting on page 17.] and that the unit is operating properly. [See **INSTRUCTIONS** starting on page 4.]

1. The water in a bath tub should never exceed 40° C (104° F). Water temperature between 38° C (100° F) and 40° C (104° F) are considered safe for a healthy adult. Bathing time should be limited to approximately 30 minutes, followed by a shower to cool down. Longer exposure may result in hyperthermia. The symptoms of this condition are nausea, dizziness and fainting, which can be fatal. Lower water temperatures are recommended for extended use (exceeding 10-15 minutes) and for young children.
2. If you will not be operating the bath system during your bath, you may fill the bathtub to any comfortable level. However, if you will operate the system, you must fill the bathtub as described in the section entitled **FINAL SYSTEM TEST & CLEAN-UP** on page 16. This will assure proper operation of the system.
3. **A few important bathing "DON'T'S"-**

## **DO NOT operate the air-whirlpool bath system if:**

- The bathtub isn't filled to required levels above air channels and/or jets.
- You're pregnant (until you've consulted your doctor).
- You're taking medications or drugs that may make you drowsy.
- You're drinking any form of alcohol.
- You've just had a meal. Wait for 30 minutes after eating.
- There is a child in the bathtub who may be left unattended at any time. Never allow small children to remain unattended in any bathtub.
- There are any small objects in the bathtub. The air-whirlpool action can move small objects at high speeds, causing pain and possible injury.
- You're smoking. The heat of burning tobacco can damage the bathtub surface. Keep tobacco products and ashtrays away from the bathtub.
- You have problems with your immunity system (until you have consulted your doctor).
- Never operate electrical appliances (television, hair dryer, radio, telephone, etc.) inside or within five feet (5') of the bath.
- You are using additional attachments and/or equipment not recommended by the manufacturer.
- You have a medical history of heart disease, low or high blood pressure, circulatory system problems, or diabetes, consult with a physician before using an air-whirlpool.
- You are under the influence of drugs, anticoagulants, stimulants, antihistamines, vasoconstrictors, vasodilators, hypnotics, narcotics, or tranquilizers.

# WHIRLPOOL USER INFORMATION

## PLEASE NOTE:

The air-whirlpool action may cause even small amounts of bubble bath or shampoo to foam excessively. Exercise moderation in experimenting with different soap products.

No servicing of this product should be done by the user. There are no user serviceable parts. All controls are located in the control recesses on the lip of the tub. These are the only controls that should be used by the consumer. Do not change or alter any of these controls under any circumstances.

Motors are self-lubricating - No lubrication required.

# FCC CONSUMER INFORMATION

## Electrical Installation Information Listed on pages 14 and 15.

This equipment generates and uses radio frequency energy and if not installed and used properly, that is, in strict accordance with the manufacturers instruction, may cause interference to radio and television reception. It has been type tested and found to comply with the limits for a class B computing device in accordance with the specifications in subpart J of part 15 of the FCC rules, which are designed to provide reasonable protection against such interference in a residential installation. However, there is no guarantee that interference will not occur in a particular installation. If this equipment does cause interference, which can be determined by turning the equipment on and off, the user is encouraged to try to correct the interference by one or more of the following measures:

- Reorient the receiving antenna.
- Relocate the receiver with respect to the bath tub.
- Move the receiver away from the bath.
- Plug the receiver into a different outlet so that the receiver and bath are on different branch circuits.
- If necessary, the user should consult the dealer or an experienced radio/television technician for additional suggestions.
- The user may find the following booklet prepared by the FCC helpful: "How To Identify and Resolve Radio-TV Interference Problems." **It is available from the U.S. Government Printing Office, Washington, DC 20402, Stock No. 004-000-00345-4.**



# Aquatic Limited Lifetime Warranty

FOR ESTATE SERIES

## Limited Warranty For Original Consumer For Household Usage

### WHAT PRODUCTS ARE COVERED

Structures and surface finishes on Whirlpools ("Whirlpools"), Air Baths ("air baths") and Soaking Tubs ("Tubs"), and their support equipment, components, attachments, controls and plumbing equipment. Different warranty periods apply to specific components.

### *Warranty Periods for Specific Components*

#### LIFETIME WARRANTY FOR WHIRLPOOL/AIR BATH/TUB SHELL, PUMP AND BLOWER

Aquatic extends to the original consumer purchaser of the acrylic, fiberglass reinforced shell, a non-transferable lifetime warranty that the shell will retain its structural integrity and configuration and be free of water loss due to a defect in the tub shell. The warranty covers the tub shell and the factory installed pump and blower against defects in material or workmanship. This warranty does not apply to all other components (attachments to the acrylic, fiberglass reinforced shell, such as plumbing, fittings and other apparatus) because these pieces are covered below under a 2 Year Warranty.

#### LIFETIME SURFACE WARRANTY FOR FACE OF WHIRLPOOL/AIR BATH/TUB

The interior surface is warranted against fading, blistering, cracking and delamination due to defects in the surface materials for life. This surface warranty extends to defects due to surface material mixing or molding. This surface warranty does not apply to fading, cracking, delamination or blistering due to excessive wear, sun fading or scouring due to cleaning.

#### 2 YEAR EQUIPMENT WARRANTY FOR SUPPORT EQUIPMENT, COMPONENTS, CONTROLS & PLUMBING EQUIPMENT

All support equipment; components, controls and plumbing equipment are warranted for 2 years from date of purchase, but not more than 3 years from date of manufacture, against defects in workmanship and materials. Light bulbs, fuses and pillows are not included in this two-year period. However, these accessories are warranted to be free from defects in materials and workmanship at the time of delivery to the original purchaser. Limited labor is covered for 2 years from purchase, but never more than 3 years from date of manufacture, for limited labor on the support equipment, controls, and plumbing.

### EXCLUSIVE REMEDY

Aquatic will, **at its option**, repair or replace (without removal or installation) the affected components of any defective Unit or System; repair or replace (without removal or installation) the entire defective Unit or System; or refund the then-current list price of the Whirlpool, Air Bath, or Tub. In all cases, a reasonable time period must be allowed for warranty repairs to be completed.

### WHAT YOU MUST DO

In order to make a claim under these warranties:

1. You must be the original consumer purchaser of the Whirlpool, Air Bath, or Tub.
2. You must promptly notify us within the warranty period of any defect and provide us with any substantiation that we may reasonably request. Contact Warranty Services: **800.945.2726 • aquaticbath.com**.
3. The Whirlpools, Air Baths, and Tubs must have been installed and maintained in accordance with good industry practice and the specific Aquatic directions contained in the Owner's Manual and Installation Guide.

### EXCLUSIONS

These warranties do not extend to or do not cover defects caused by:

1. Shipping damage by carriers or installation errors.
2. Accident, acts of God, abuse or misuse.
3. Unreasonable use (including any use for non-bathing purposes or failure to provide reasonable and necessary maintenance as specified in Aquatic Owner's Manual and Installation Guide supplied with the Whirlpool, Air Bath or Tub).
4. Any alteration, customization, or modification of the Whirlpool/Air Bath/Tub or its components.

### LIMITATIONS

1. **Aquatic whirlpools and tubs sold for industrial, commercial and hotel use** are warranted for two years, but not more than 3 years from date of manufacture, with a 2 year limited warranty that the shell will retain its structural integrity and configuration and be free of water loss due to a defect in the tub. The interior surface/face of the whirlpool/air bath/tub is warranted against fading, blistering, cracking and delamination due to defects in the surface materials for 2 years as well. All support equipment, components, controls and plumbing equipment and limited labor on the support equipment, controls, or plumbing are warranted for 1 year from date of purchase, but not more than 2 years from date of manufacture. Pump seals, "O" rings, light bulbs, fuses and pillows are not included in this two-year period. However, these accessories are warranted to be free from defects in materials and workmanship at the time of delivery to the original purchaser.
2. **In all cases, Aquatic reserves the right to fully satisfy its obligations under the Limited Warranties by refunding the then-current list price of the defective Whirlpool, Air Bath, or Tub (or, if the Whirlpool, Air Bath, or Tub has been discontinued, of the most nearly comparable current product).**
3. **THESE WARRANTIES ARE NON-TRANSFERABLE TO ANY OTHER PURCHASER OR PARTY OTHER THAN THE ORIGINAL CONSUMER. NO OTHER AGENT OR PARTY CAN GIVE ANY OTHER WARRANTY OR PROMISE. THIS IS THE SOLE WARRANTY FOR YOUR Aquatic PRODUCT.**
4. Aquatic will not cover any installation or reinstallation costs related to this warranty, except under the limited labor allowance under the 2 Year Equipment Warranty above.

### GENERAL

This warranty gives you specific legal rights; you may also have other rights, which vary from state to state. THE DURATION OF ANY IMPLIED WARRANTIES, INCLUDING THE IMPLIED WARRANTIES OF MERCHANTABILITY AND FITNESS FOR A PARTICULAR PURPOSE, ARE LIMITED TO THE DURATION OF THE EXPRESS WARRANTIES HEREIN. Aquatic EXPRESSLY EXCLUDES INCIDENTAL AND CONSEQUENTIAL DAMAGES, TO INCLUDE LOSS OF TIME, INCONVENIENCE, OR LOSS OF USE OF RESIDENCE, FOR ANY BREACH OF THE EXPRESS OR IMPLIED WARRANTY, INCLUDING THE IMPLIED WARRANTIES OF MERCHANTABILITY OR FITNESS FOR A PARTICULAR PURPOSE.

SOME STATES DO NOT ALLOW ANY LIMITATION ON HOW LONG AN IMPLIED WARRANTY LASTS, OR THE EXCLUSION OR LIMITATION OF INCIDENTAL OR CONSEQUENTIAL DAMAGES; SO THE ABOVE EXCLUSION MAY NOT APPLY TO YOU.

# INSTALLATION INSTRUCTIONS

READ ALL INSTRUCTIONS CAREFULLY BEFORE INSTALLATION

## PRE-INSTALLATION PROCEDURES

**PLEASE NOTE: THE MANUFACTURER ACCEPTS A  $\pm 3/8$ " VARIANCE. THERE ARE VARIATIONS ON EACH TUB AND SPECIFICATIONS ARE SUBJECT TO CHANGE AS WE IMPROVE UPON OUR PRODUCT AS REQUIRED.**

THE DIMENSIONS NEEDED FOR SITE PREPARATION AND STRUCTURE BUILDINGS SHOULD BE MEASURED FROM THE TUB; AQUATIC, ASSUMES NO RESPONSIBILITY FOR PREPARATORY WORK.

**Note: A good knowledge of construction techniques, plumbing and electrical installation according to codes are required for proper installation. We recommend that a qualified licensed contractor perform the installation of all Aquatic products. Our warranty does not cover improper installation related problems.**

1. Immediately upon receiving your Aquatic air-whirlpool bath, inspect it thoroughly for freight damage. If necessary, contact your dealer/distributor immediately (your dealer/distributor must contact Aquatic, within 24 hours of receiving unit to file a claim.) Should inspection indicate any damage, do not install the bath.
2. All baths are filled with water and operated in our manufacturing facility prior to shipment. Inspectors ensure watertight operation, however, rough handling may cause leaks which may be detected prior to installation.

**DAMAGE OR DEFECT TO THE FINISH CLAIMED AFTER THE BATH IS INSTALLED IS NOT COVERED UNDER THE WARRANTY.**

### To inspect:

1. Place the tub in an area where it may be drained after testing.
2. Fill the tub with hot water (approximately 100° F) to the overflow and allow to stand for a few minutes. Carefully inspect all fittings and connections for leaks.
3. Plug in pump and blower cords and run pump for 10 minutes.
4. With the pump running, turn on the blower. Check all functions.
5. Inspect the tub completely. Any defect must be reported to Aquatic, prior to installation in order to have it covered by warranty. Should inspection indicate any damage, do not install the bath.
6. Check to ensure that your installation will conform to all applicable codes and secure necessary permits. All electrical and plumbing connections should be made by qualified electricians and plumbers.

**DAMAGE OR LEAKS CLAIMED AFTER THE BATH IS INSTALLED ARE NOT COVERED UNDER THE WARRANTY.**

**WARNING: FAILURE TO FOLLOW THESE INSTRUCTIONS DURING INSTALLATION WILL RESULT IN TERMINATION OF THE WARRANTY:**

Do not lift the tub by any portion of the plumbing or pump.  
Do not stand in the tub during construction.

**DO NOT MAKE ANY ALTERATIONS, ADDITIONS, OR DELETIONS TO THE WHIRLPOOL SYSTEM, PUMP OR BATH.**

**WARNING:** Whirlpool pump and piping are factory assembled. Relocation of pump or other modifications could adversely affect the performance and safe operation of this air-whirlpool. Aquatic, shall not be liable under its warranty or otherwise for personal injury or damage caused by any such unauthorized modification.

**QUIETNESS OF OPERATION:** Aquatic has engineered their whirlpool baths from base to lip to ensure quality, value, functional design, and maximum bathing comfort. However, installation is accountable for as much as 50% of a tub's operating quietness. Please ensure the following:

- The floor structure is adequate to support the installation.
- For quieter operation and heat retention conservation, the walls surrounding the air-whirlpool may be insulated.
- Insulate the tub surround. Do not allow any insulation to come within 3 feet of the blower and pump. The area around the blower and pump must be clean and free of any foreign matter.
- Leave 1/8" to 3/16" gap between tub lip and surround.



# INSTALLATION INSTRUCTIONS

## STRUCTURAL PREPARATION

**Note:** The bath should remain in its shipping carton until time of installation.

1. Literature dimensions are for reference only. Installation dimensions should be taken directly from the tub.
2. Building materials and wiring should be routed away from the pump body or other heat-producing components. An access panel of 16" w x 16" h minimum must be provided at the pump end of the air-whirlpool allowing sufficient clearance to make final connections and for servicing the pump, blower, heater and control units. A minimum ventilation opening of 2" x 4" for the blower is required and should be designed to draw in ambient air at a minimum of 72°F. Access may be through the wall or platform apron at the end of the unit. In the case of sunken installations, access should be made through the ceiling below.

**IT IS THE INSTALLER'S RESPONSIBILITY TO PROVIDE SUFFICIENT SERVICE ACCESS.  
MAKE ABSOLUTELY CERTAIN THAT ACCESS PANELS AND/OR SERVICE OPENINGS ARE PROPERLY  
PLACED AND THAT ALL POSSIBLE AREAS WHERE SERVICE MAY BE REQUIRED ARE ACCESSIBLE.**

3. Install the drain fitting to the bath. Clearance may be needed for the drain by cutting away the subfloor (where possible) or by blocking below the tub as may be required. **WARNING: FACTORY SKIRTS DO NOT ALLOW FOR BLOCKING UP OF THE TUB BASE.** All blocking must be solid and provide uniform support to the tub base.  
**PLEASE NOTE: Estate versions with the black ABS support bases need to be set in a bed of mortar.** This will help in leveling the tub on uneven floors and will help in reducing vibrations and noise.
4. Tub must rest entirely on all leveling feet or ABS Support Base. **DO NOT SUPPORT THE WEIGHT OF THE TUB BY THE RIM.** Lift unit and place into framework. Secure the unit by fastening the bottom feet to the sub floor with any construction adhesive caulk. For quieter operation and heat conservation, the walls surrounding the air-whirlpool may be insulated.
5. Frame out under the tub rim as shown in one of the illustrations below. **NOTE:** Due to the variety of installations possible, framing procedures other than those described may be required. Plumb in selected location using a level. Level front to back and across both sides. A ledge under the rim, or an apron without a ledge, may be constructed as required (see Figures 1A, 1B and 1C). Where installation will be against a wall, stud wall framing should allow for wall sheathing material to run full length to the floor (see Figure 1D). Install tub firmly against sheathing as indicated, with blocking below rim to prevent deflection or movement of tub. To prevent a rocking movement of tub after installation, it is important to have rim in contact, but not supported by blocking material.

**NOTE: Watertight installation of the drain and overflow is the installer's responsibility. Drain and/or overflow leakage is not included in the warranty of this product.**

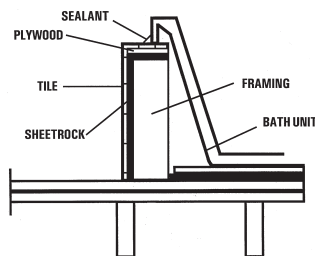

1A Ledge Installation - 1

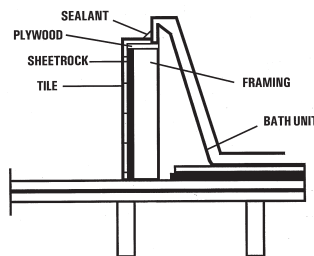

1B Ledge Installation - 2

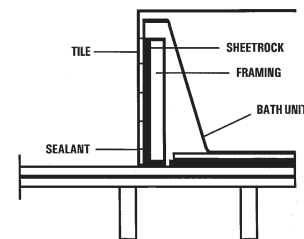

1C Apron Installation

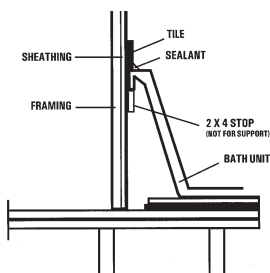

1D Wall Installation

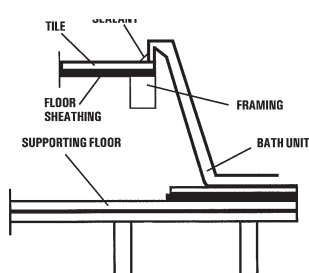

1E Sunken Installation

**WARNING: ALL ELECTRICAL CONNECTIONS SHOULD BE MADE BY A LOCALLY LICENSED ELECTRICIAN.**

# INSTALLATION INSTRUCTIONS

## STRUCTURAL PREPARATION (CONTINUED)

- When placing the tub on a platform or cut out, the opening should be 1" smaller than the specified rim dimensions. Extreme care must be taken in this type of installation to ensure the tub will come to rest entirely on the leveling feet or ABS Support Base.

## FACTORY INSTALLED TILE FLANGE

SEE FIGURE 2

- Install the air-whirlpool bath unit per the instructions provided in this manual.  
**CAUTION: THE TILE FLANGE DOES NOT SUPPORT THE TUB!** A ledger board must be provided under the bath rim as indicated in the installation instructions. Take care to ensure tub is not hanging from the ledger boards, as this will void your warranty.
- Use nails or screws to secure the flange into the studs around the bath.
- Install water resistant drywall against the tile flange and flush to the top of the air-whirlpool deck. Install the tile or other finishing materials. Apply a second bead of silicone between the first course of tile and the bath deck.

**NOTE:** Before tub is used, the air-whirlpool system should be cleaned in accordance with the procedures on Page 21 of this manual.

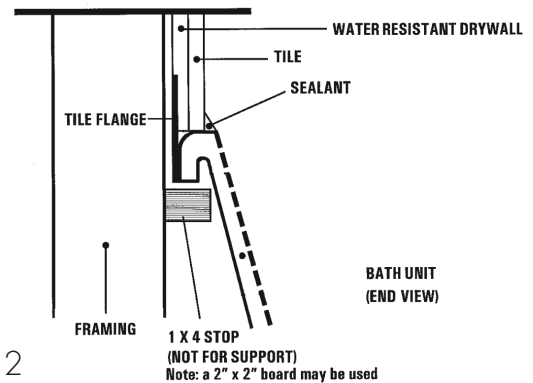

Figure 2

## INTEGRALLY SKIRTED MODELS

### Alcove Framing and Pre-Installation Procedures:

- Protect interior of tub throughout installation procedures.
- Before moving unit into alcove please refer to Electrical Installation Procedures on pages 14-15. (Electrical hookups will be difficult to perform if unit is installed first.)

### IMPORTANT! BEFORE INSTALLATION BEGINS, MAKE SURE THAT:

- Framed-in alcove is of proper size, square and plumb.
- Walls and floors meet fire safety requirements of local building code and/or FHA/HUD Minimum Property Standards. Before installation of the panel, fill the unit, test the air-whirlpool system for proper operation and check for leaks, then drain.
- A mortar base is prepared (this is mandatory for proper installation).

# INSTALLATION INSTRUCTIONS

## Installation Procedures for Integrally Skirted Models

1. To avoid obstructions during installation, make sure water lines, spout pipes and valve plumbing do not project into alcove.
2. **Ledger Strip:** Fasten a 1" x 3" (25mm x 75 mm) ledger strip along rear for alcove and along both sides in corner installations at Dimension LH. (see Figure 3A)
3. Place three or four mounds of mortar away from drain hole in a line or square, approximately twice as high as the cavity under the tub bottom.
4. Place tub into alcove with front skirt firmly on floor and depress mortar mounds. Make certain that back ledge of tub rests firmly on ledger strip. (see Figure 3A)
5. See and follow **Sealing & Finishing** Figure 3B.

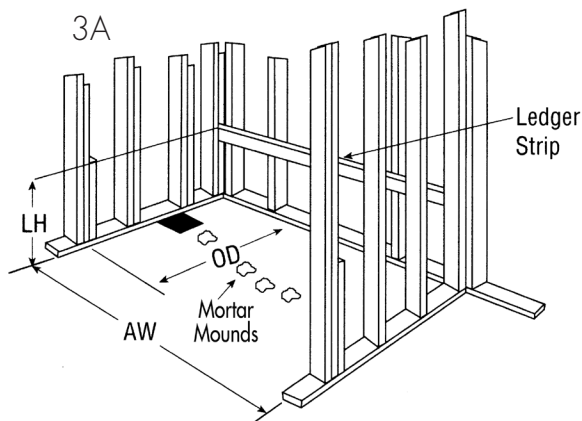

3B

### Sealing & Finishing Typical methods of sealing and finishing

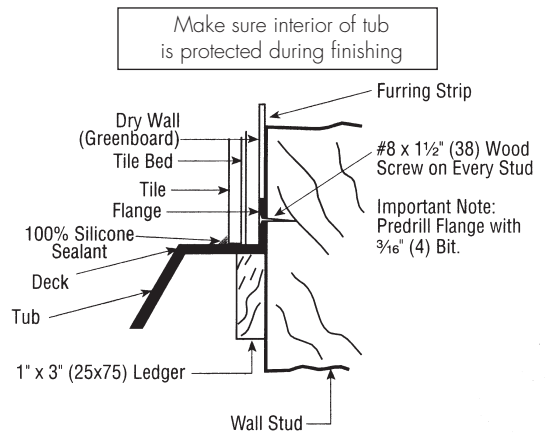

## Removable Skirt Panels for Integrally Skirted Models

These models are offered with removable panels. It provides a flush-to-wall installation (sheet rock overlaps skirt while still providing access). The skirt features a decorative removable panel enabling easy access to motor, pump, blower and electrical hookups. Clips or snap-ons enable simple and quick removal of skirt access panel.

**Important:** Before installation of the panel, fill the unit, test the air-whirlpool system for proper operation and check for leaks, then drain.

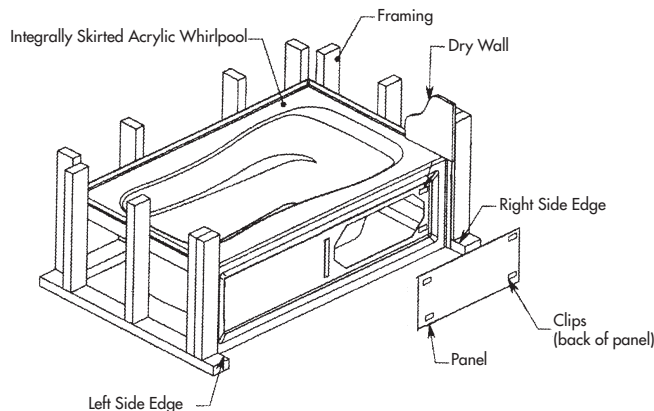

Figure 4



# INSTALLATION INSTRUCTIONS

## FRAMING DIAGRAMS

1. Protect interior of tub throughout installation process.
2. Framing and supports will vary according to the model and type of installation selected.
3. Please refer back to the unit's Technical Data sheet for specific dimensions located at [www.aquaticbath.com](http://www.aquaticbath.com).

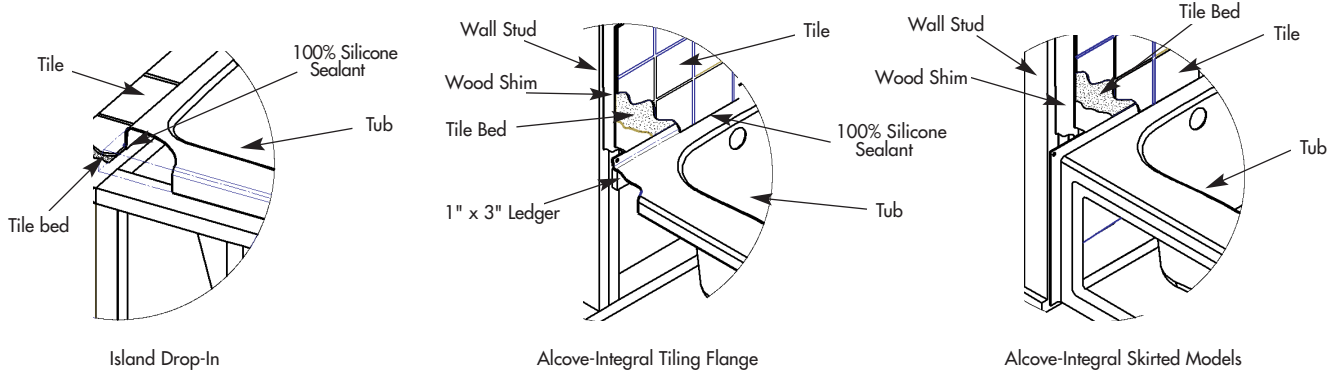

### RECTANGULAR MODELS

### CORNER MODELS

### OVAL MODELS

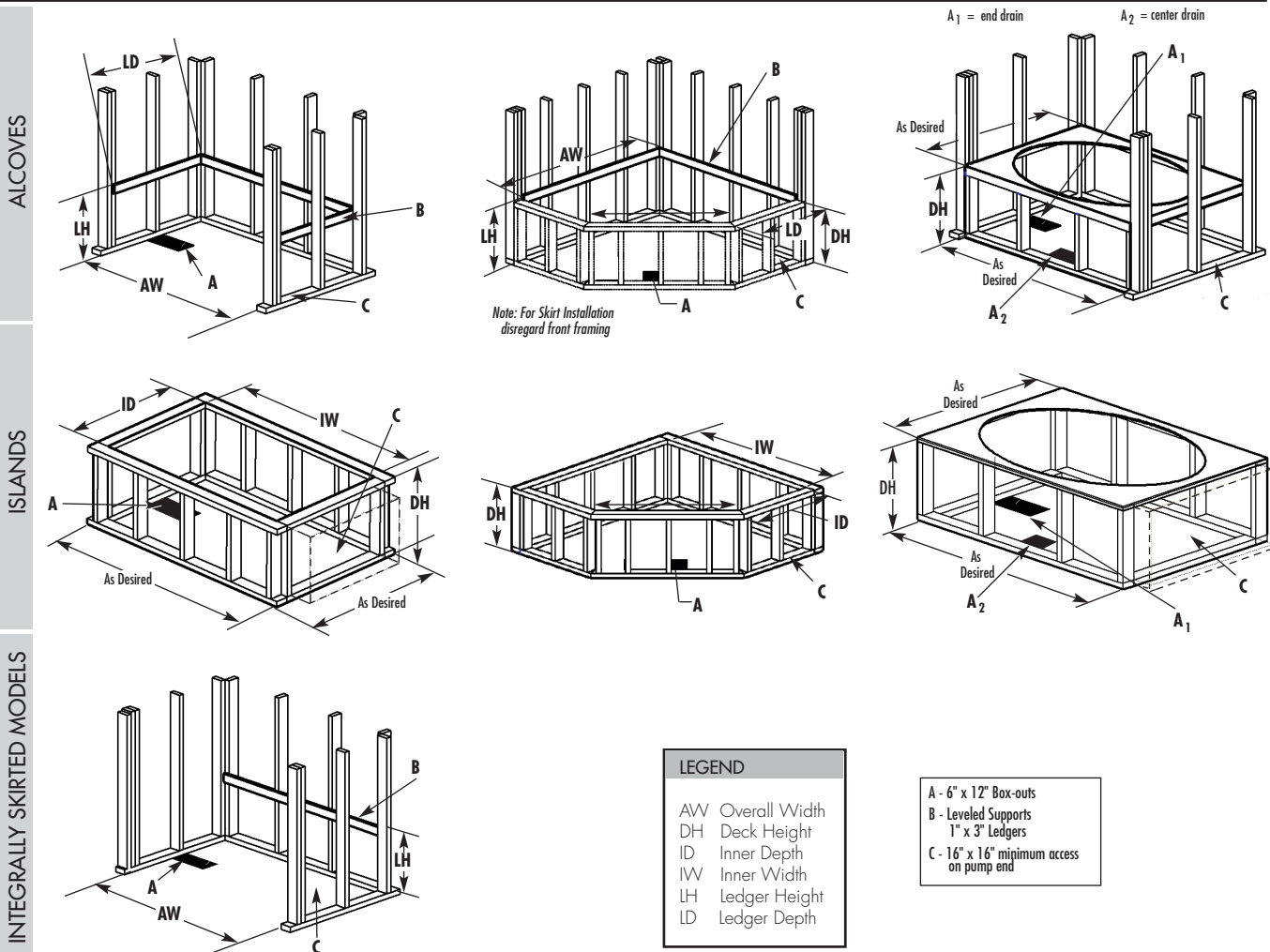

# INSTALLATION INSTRUCTIONS

## DECK CUTOUTS

A paper template will be enclosed with all rounded-edged models. Use the directions on the paper template for cutout dimensions. **If the paper template has been lost or needs replacement, please contact Customer Service at: 800.945.2726.**

### USING THE CUTOUT TEMPLATE

Draw a center line horizontally and vertically on a 1" thick plywood deck. Place the template in the upper left hand quadrant, noted as Quadrant 1 on the diagram below. Trace template to outline Quadrant 1. Flip the paper cutout horizontally, making sure to match the dotted center line on the template with the center line on the plywood. Trace again to outline Quadrant 2. Repeat until the remaining quadrants of the cutout have been traced.

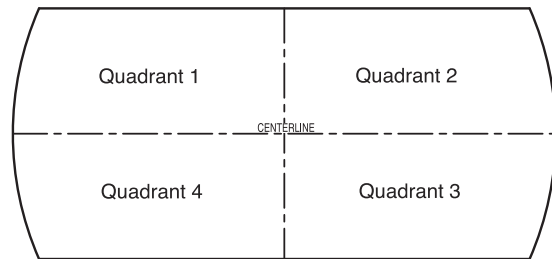
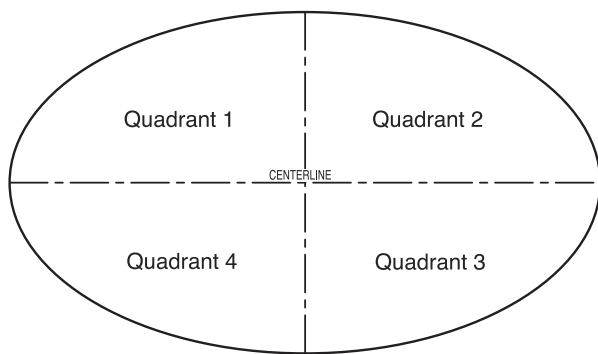

### CORNER MODELS

On a 1" thick plywood deck, place the template in the upper section noted as Section 1 in the diagram. Trace Section 1 to establish the centerline and front edge of the cutout. Flip the template along the centerline and trace to complete the other half of the unit noted as Section 2 in the diagram below.

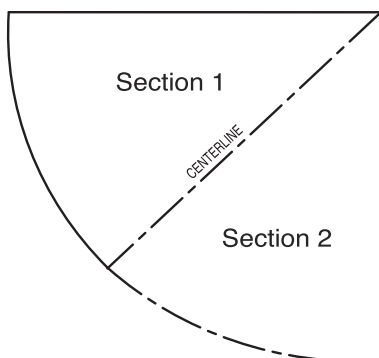

### RECTANGLE MODELS

Using a 1" thick plywood deck, the cutout should be 2" smaller than the overall tub dimensions (length & width), for 1" overhangs on all sides. For example, a 72" x 42" unit should have a deck cutout of 70" x 40". Additional dimensions can be found in the technical data sheets at [www.aquaticbath.com](http://www.aquaticbath.com).

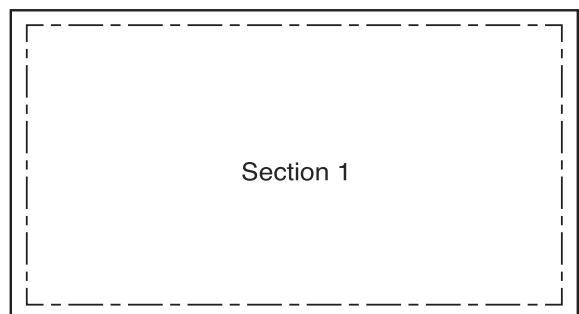

# INSTALLATION INSTRUCTIONS

## PLUMBING

1. After securing tub in place, normal waste and overflow and valves are installed per normal plumbing procedures, in accordance with all state and local standards.
2. Install standard 1-1/2" trap to drain and overflow. Before proceeding, make a final operational check by filling tub with water to overflow and operate pump for 5 minutes. Check for leaks carefully both while pump is running and has been turned off. Allow water to stand in tub for at least 30 minutes before draining. **Aquatic WILL NOT BE RESPONSIBLE FOR WATER DAMAGE OF ANY KIND IN CONNECTION WITH ONE OF OUR WHIRLPOOL BATHS.**

**NOTE:** For Rough-in measurements please refer to unit's technical data sheet.

## ELECTRICAL INSTALLATION

**WARNING:** ALL ELECTRICAL CONNECTIONS SHOULD BE MADE BY A LICENSED, LOCALLY CERTIFIED ELECTRICIAN, IN ACCORDANCE WITH THE REQUIREMENTS OF THE NATIONAL ELECTRICAL CODES AND PROCEDURES.

**WARNING:** When using electrical products, precautions should always be followed, including the following:

**DANGER: RISK OF ELECTRIC SHOCK!**

**GFCIs are not supplied, however we do specify their use.  
All known code authorities require GFCIs.**

**Estate air-whirlpool baths** will need to be hard-wired to the outlets provided. See the following directions and Figure on page 15.

Two junction boxes will be mounted to the frame of the whirlpool. One of the two boxes will have one outlet and will be labeled "Blower". Remove the cover and connect a 14/2 with ground Romex wire from a 15 amp 1-pole GFCI breaker (not supplied) in the main circuit breaker panel. Connect the black wire to the hot side of the receptacle, the white wire to the neutral side of the receptacle and the green wire to the ground. Replace the cover and plug in the blower.

The second junction box will have one outlet with two ports. Remove the cover from the one labeled "Main", and run Romex 14/2 with ground from a 15 amp 1-pole GFCI breaker (not supplied) located in the breaker panel. Connect the black wire to the hot side of the receptacle, the white wire to the neutral side of the receptacle and the green wire to the ground. For the one labeled "Heater" run Romex 14/2 with ground from a 15 amp 1-pole GFCI breaker (not supplied) located in the breaker panel. Connect the black wire to the hot side of the receptacle, the white wire to the neutral side of the receptacle and the green wire to the ground. Replace the cover and plug in the pump to the outlet labeled "Main". Plug in the heater to the outlet labeled "Heater".

**CAUTION:** Before use of the blower, pump, and heater, test the GFCI for proper operation. The blower, pump and heater should turn off when the GFCI "Test" button is pushed.

# INSTALLATION INSTRUCTIONS

## ELECTRICAL INSTALLATION (CONTINUED)

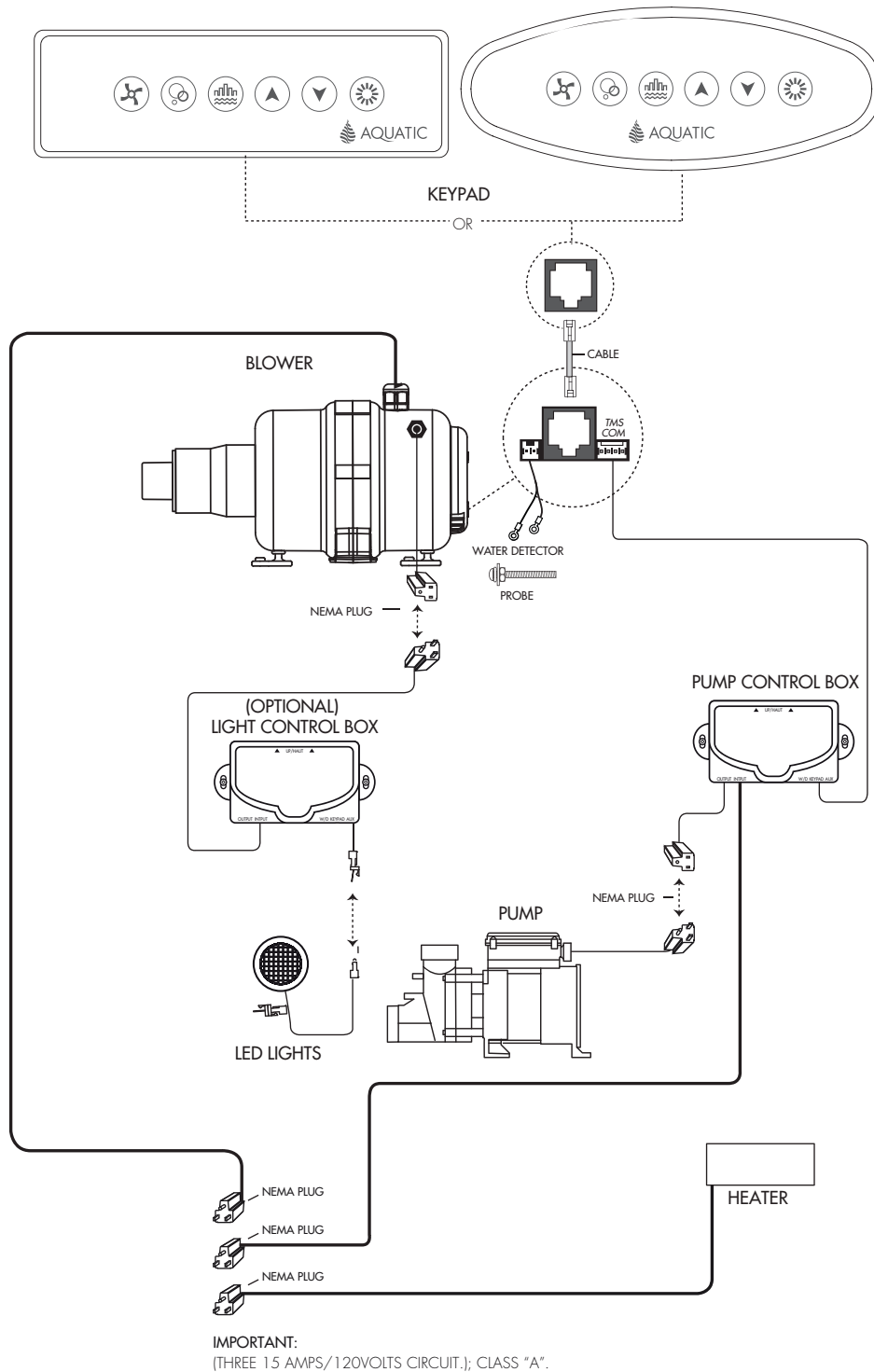

Figure 5

# INSTALLATION INSTRUCTIONS

## FINAL SYSTEM TEST & CLEAN-UP

### System Test

To test system, follow these steps in order listed:

1. Fill clean tub with water to a point no less than 2" (50) above the highest jet.
2. To test the Ground-Fault Circuit-Interrupter (GFCI), push the test button. The GFCI should interrupt power. Push the reset button. Power should be resorted. If the GFCI fails to operate in this manner, there is a ground current flowing, indicating the possibility of an electric shock. Do not use this unit. Disconnect the unit and have the problem corrected by a licensed electrician before using.
3. Push on/off button on the whirlpool.
4. Allow system to run a full 10 minutes.
5. Through access door or removable skirt, check for leaks in whirlpool plumbing system. Make sure half-unions at both ends of pump are hand-tight. If leakage is occurring at any other points, notify distributor.
6. If any electrical malfunctions occur, immediately unplug the unit and consult a licensed electrician. Malfunctions of the pump/motor, whirlpool controls or the circulating system should be reported to the distributor who supplied the whirlpool tub.

### Clean-up

1. Remove all construction residue and foreign materials. Wipe unit clean with a damp rag, otherwise staining may occur.
2. Plaster may be removed by scraping with the edge of a piece of wood or rigid plastic. DO NOT use metal scraper. For spots left by plaster or grout: rub lightly with a liquid detergent (Spic-N-Span® or similar) on a damp cloth or sponge.
3. **DO NOT** use abrasive cleaners, scouring powders, steel wool, wire brushes or anything else that may harm or dull the surface.
4. Paint, tar or stubborn stains may be removed with paint thinner, turpentine or rubbing alcohol. To avoid discoloration, cleaners containing petroleum distillate must not remain on surfaces. NEVER use lacquer thinner or chlorinated solvents.
5. Dulled areas can be restored to a high gloss with white or cream-colored automotive rubbing compound, followed by application of carnauba wax or white or cream automotive paste wax and buffing.
6. Major gouges require professional repair. Contact Aquatic to arrange factory-authorized repair services.



# OPERATION

## BATHSIDE CONTROL SYSTEMS

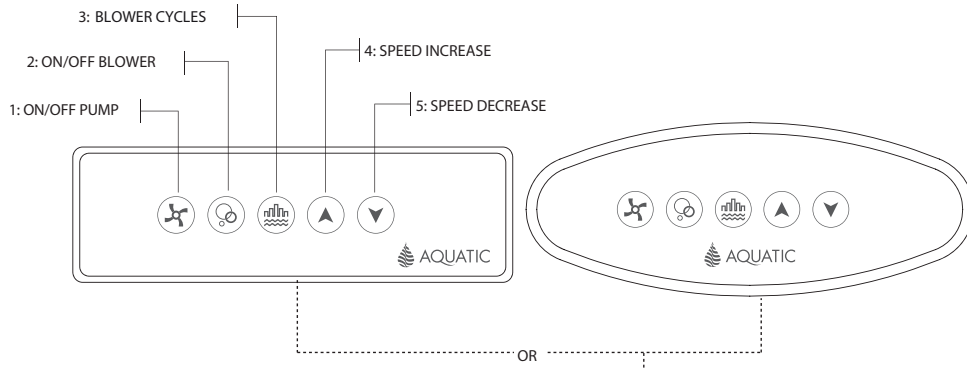

Keypad Functions	LED
<b>1: On/Off Pump</b>	
1st Press: The pump starts	ON
2nd Press: The pump stops	OFF
<b>2: ON/OFF BLOWER</b>	
1st Press: The blower starts	ON
2nd Press: The blower stops	OFF
<b>3: BLOWER CYCLES</b>	
1st Press: Wave Cycle - Speed goes gradually from maximum to minimum.	ON
2nd Press: Pulse Cycle - Speed goes from minimum then straight back to maximum.	BLINK
3rd Press: Returns to maximum speed	OFF
<b>4: SPEED INCREASE</b>	
1st Press: Press and hold to increase the blower speed, release pressure at the desired speed. When in cycles mode, increases the speed at which the cycle operates.	ON (WHEN PRESSED)
<b>5: SPEED DECREASE</b>	
1st Press: Press and hold to decrease the blower speed, release pressure at the desired speed. When in cycles mode, decreases the speed at which the cycle operates.	ON (WHEN PRESSED)
<b>Advanced Programming</b>	
<b>DRYING CYCLE WITH WATER DETECTORS</b> The drying cycle will activate 20 minutes after the bathtub is emptied even if the system was not used. The blower touch LED blinks while waiting for the purge cycle.	
<b>INTEGRATED 20 MINUTE AUTOMATIC TIMER</b> Integrated 20 minute automatic timer on the complete system. Count down starts with the last system turned on.	

Figure 6

# OPERATION

## BATHSIDE CONTROL SYSTEMS W/ OPTIONAL CHROMATHERAPY

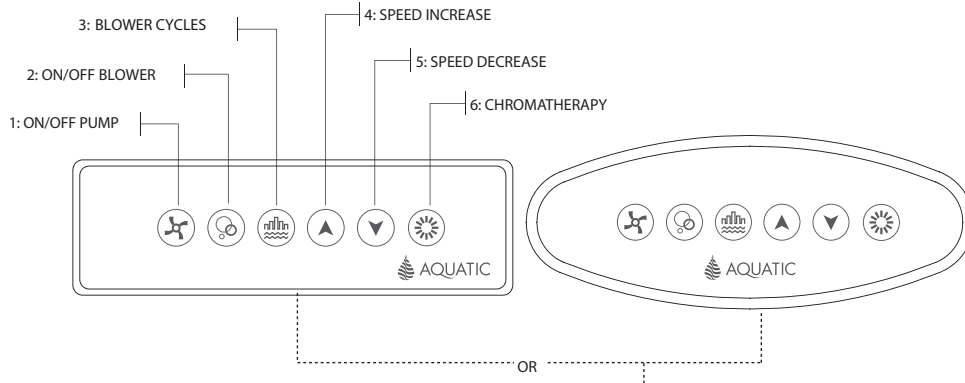

Keypad Functions	LED
<b>1: On/Off Pump</b>	
1st Press: The pump starts	ON
2nd Press: The pump stops	OFF
<b>2: ON/OFF BLOWER</b>	
1st Press: The blower starts	ON
2nd Press: The blower stops	OFF
<b>3: BLOWER CYCLES</b>	
1st Press: Wave Cycle - Speed goes gradually from maximum to minimum.	ON
2nd Press: Pulse Cycle - Speed goes from minimum then straight back to maximum.	BLINK
3rd Press: Returns to maximum speed	OFF
<b>4: SPEED INCREASE</b>	
1st Press: Press and hold to increase the blower speed, release pressure at the desired speed. When in cycles mode, increases the speed at which the cycle operates.	ON (WHEN PRESSED)
<b>5: SPEED DECREASE</b>	
1st Press: Press and hold to decrease the blower speed, release pressure at the desired speed. When in cycles mode, decreases the speed at which the cycle operates.	ON (WHEN PRESSED)
<b>6: Chromatherapy</b>	
1st Press: Turn on the light in white	
2nd Press: Rainbow cycle – Low speed	
3rd Press: Rainbow cycle – High speed	
4th Press: Turquoise	
5th Press: Blue	
6th Press: Magenta	
7th Press: Red	
8th Press: Orange	
9th Press: Yellow	
10th Press: Green	
11th Press Turn off the light (Press and hold 2 seconds at any time to turn off the light.)	
<b>Advanced Programming</b>	
<b>DRYING CYCLE WITH WATER DETECTORS</b>	
The drying cycle will activate 20 minutes after the bathtub is emptied even if the system was not used. The blower touch LED blinks while waiting for the purge cycle.	

Figure 7

# OPERATION

**NOTE:** DO NOT START PUMP UNTIL ALL JETS ARE SUBMERGED. WATER LEVEL SHOULD BE 2" ABOVE HIGHEST JET.

## JET OPERATIONS

All Estate Series jets are removable, and can simply be put into the dishwasher for easy cleaning. (Note: use top rack and remove before drying cycle.)

### Estate Series Whirlpool Jets

The Estate Series combines Full-Size Pressure-Flo Hydrotherapy Jets, Aquatic Rotary Massage Jets and StressEaz Neck and Shoulder Massage Jets (most models) to provide an invigorating hydrotherapy experience.

#### Full Size Pressure-Flo Hydrotherapy Jet:

Designed to facilitate targeted, deep tissue massage therapy. Each Full Size Pressure-Flo Hydrotherapy jet is fully adjustable for direction of water flow and intensity of pressure.

#### StressEaz Neck and Shoulder Massage Jet:

Aquatic StressEaz Jets feature two side-by-side oval ports through which water moves simultaneously in opposite directions to create a constant circular motion. This unique design effectively creates a consistent, even massage for the user's neck and shoulder areas.

- **To adjust pressure:**
  1. Grasp the outer ring of the jet.
  2. Turn the outer ring clockwise to increase flow, counter-clockwise to reduce flow.
- **To remove jet (see Figure 8):**
  1. Grasp the outer ring of the jet.
  2. Turn the jet counter-clockwise, until the jet clicks, then pull.
- **To replace jet (see Figure 8):**
  1. Insert the jet into jet housing.
  2. Turn the jet clockwise, past point of resistance, until the jet clicks.

**Note:** Rotational swirl jet added for targeted lower back massage.

Figure 8



## OPERATION

### TO REPLACE LED LIGHT

1. Disconnect the power to your bathtub.
2. Drain the bathtub.
3. Open the lens of the fixture using ONLY the proper tool provided for that purpose (see Figure 9). Do not attempt to remove the lens without the provided tool.
4. Replace your LED light (replacement LED lights can be obtained from Aquatic).

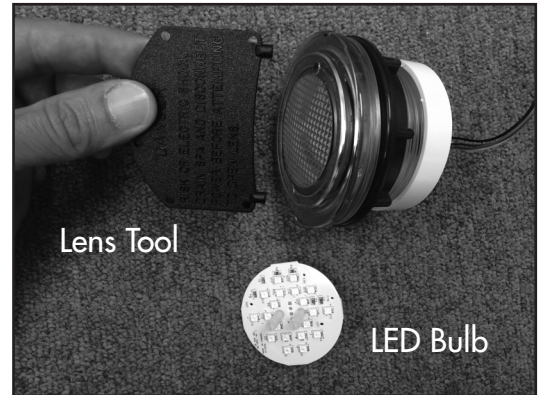

Figure 9

**NOTE:** Do not twist LED light into socket. Use gentle pressure and push LED light into place.

# TUB CARE

## MAINTENANCE

Before tub is used, the air-whirlpool system should be cleaned and disinfected. Remove all debris and clean tub before putting air-whirlpool into service. **DO NOT USE ABRASIVE CLEANERS ON THE ACRYLIC FINISH.** Use a non-abrasive detergent and rinse well after cleaning.

- Fill the tub with HOT water to a level 2" above the highest jet.
- Add 4 – 6 tablespoons of low-sudsing automatic dishwashing detergent and no more than 24 – 48 ounces of household bleach to the water.
- Operate air-whirlpool for 10 minutes. Drain. **Note:** To effectively clean both the whirlpool and air bath system, you must operate them both.
- Refill with cold water and operate whirlpool for 5 minutes. Drain.

### Whirlpool System Cleaning

To remove accumulations of bath residue from the air-whirlpool system, we recommend that you purge it at least twice a month, or more depending on usage. To do this, follow this simple procedure. Fill the bath with hot water (not exceeding 140° F). Add to the hot water, 4 – 6 tablespoons of low foaming detergent such as liquid Cascade or Calgonite and 24 – 48 oz. of liquid household bleach, such as Clorox. Do NOT use splashless bleach. [Use lesser amounts for 5-foot bathtubs, greater amounts for larger bathtubs]. Run the bath for 5 to 10 minutes. Drain the bath completely and refill with cold water only. Run the whirlpool for 5 to 10 minutes, then drain the bath completely. Depending on the usage and/or the content of the local water supply, more frequent purging may be necessary.

### Air Bath System Cleaning

**NOTE: DO NOT TURN THE PUMP ON DURING THE AIR BATH CLEANING.**

Before tub is used, your air bath and plumbing system should be flushed. Close the drain. Fill bath with hot water to at least six inches above air injector holes. Add 2 teaspoons of low sudsing automatic dishwashing detergent and no more than 4 ounces of bleach to the water. **DO NOT** use bleach or other chlorinated cleansers on metal trim surrounding control panels. Turn blower on for approximately two minutes to mix cleaner with water. Shut blower down and allow cleaner to soak in the bath for approximately two hours. Turn ON air bath and run for approximately five minutes. Turn air bath unit OFF and drain tub. Aquatic recommends the above cleaning process on your air bath system once a month.

**NOTE: DO NOT USE OIL OR OIL BASED BATH ADDITIVES.**

If you want to use any kind of bath additive, use only a small amount of low-foaming powder or crystal substance; the whirlpool action intensifies the foaming properties of soaps. The use of certain bubble baths and bath additives may increase the level of accumulations of bath residue in the whirlpool system. If excess accumulations persist, you should discontinue use of these products.

If you have followed the monthly purging instructions and still have an excess accumulation of bath residue and desire an alternative cleaning mechanism, we recommend **SUPER SYSTEMS CLEAN PLUS** manufactured by Stearns Packaging Corporation to rectify this condition. This may be obtained by calling Aquatic, at (800) 945-2726. It is recommended that you follow the instructions provided by the manufacturer with the product. Repeated use may be necessary. **SUPER SYSTEMS CLEAN PLUS** does not replace the necessity to purge your whirlpool system at least twice a month with a low foaming detergent and bleach.

### Surface Cleaning

Use common household, non-abrasive cleaners for most cleaning jobs. Rinse well and dry with a clean cloth. Never use abrasive cleaners. Do not allow your Lucite® acrylic surface to come into contact with products such as acetone (nail polish remover), nail polish, dry cleaning solution, lacquer thinners, gasoline, pine oil, etc. Remove dust with a soft, dry cloth. Clean grease, oil, paint, and ink stains with isopropyl (rubbing) alcohol.

# TUB CARE

## Jet Cleaning

All Estate Series jets are removable, and can simply be put into the dishwasher for easy cleaning. See **JET OPERATION** for removal, page 19. (**NOTE:** Use top rack of dishwasher and remove before the drying cycle starts.)

## Surface Scratch Removal

Minor scratches may be removed by polishing your tub with a non-abrasive car polish, followed by buffing. Deeper scratches can be removed by:

- Sanding with wet 400 grit sandpaper.
- Sanding with wet 600 grit sandpaper.
- Sanding with wet micro-grit sandpaper.
- Buff out using car polish.

## REPAIR

The installation and service of your whirlpool bath should be performed only by a qualified service technician. Remember when contacting your dealer always have your serial number, proof of purchase and model number available. This will ensure a quick response on warranty items.

The model and serial numbers are located above the pump on the backside of the whirlpool.

**NOTE: ALL WARRANTY REPAIRS MUST BE AUTHORIZED BY AQUATIC BEFORE WORK IS STARTED. FOR SERVICE, ALWAYS CONTACT YOUR DEALER.**

**CAUTION:** Care should be taken to prevent inappropriate chemicals coming in contact with the Lucite® acrylic surface. Please read and observe all instructions and/or warnings on containers containing substances you contemplate applying to your whirlpool. Any failure to comply may void your warranty.

# WATER QUALITY

## CHEMICAL & WATER QUALITY

Owners of fill and drain air bathtubs need to know basic information concerning water quality, how it affects the performance and enjoyment of the operation of their tubs, and steps that can be taken by the owner to correct related problems. Important issues are the microbiological and chemical quality of the water.

### 1. Microbiological Quality

Microbes are present in water supplied by individual wells or water systems and even in the air around us. These microbes are usually in amounts below what is noticeable. Microbes from the water or air or from a bather's body may settle on wet surfaces such as a bathtub surface or piping system where they can grow in numbers. With regards to air tubs, brown/black fungi/mold or pigmented (colored) bacteria can be noted.

**Fungi/Mold** - Fungi and mold are always present. Usually the levels are such that we don't notice them. When moisture and temperature are sufficient, the organisms will grow to levels that we may smell and/or see. The best examples of such growth is the very common black growth on the bottom of shower curtains. The best solution to keep these surfaces free from the growth is frequent cleaning.

**Pigmented Bacteria** - A pinkish substance may appear on bathroom fixtures that is very persistent, appearing in the shower, sink and along the water line of toilet bowls. The residue is less likely a problem associated with water quality than with naturally occurring airborne bacteria. The bacteria may produce a pinkish film, and sometimes a dark gray film, on surfaces that are regularly moist, including toilet bowls, shower heads, sink drains, and tiles. The problem is more common in humid areas of the country. In any particular case, the determination of the exact species of bacteria causing the problem would require lengthy and costly laboratory testing; however, most experts believe the bacteria responsible is *Serratia marcescens*. These bacteria thrive on moisture, dust and phosphates, and are widely distributed in soil, food and also in animals. The best solution to keep these surfaces free from the bacterial film is continual cleaning. A chlorine containing compound is the best cleaner. Avoid abrasives to limit scratching fixtures, which will make them even more susceptible to bacteria.

### 2. Chemical Quality

The water supplied by individual wells or water systems always contains chemicals, usually in amounts below those which the consumer would notice. Examples of such chemicals, which are of potential concern for the owners of fill and drain air bathtubs, are calcium and magnesium salts, copper, iron, manganese and sulfates. When these chemicals are present in sufficient amounts, they may cause problems in air bathtubs. You should contact your water supply or treatment company and follow their suggestions for treatment.

**Calcium and Magnesium Salts** - Collectively, the various compounds of calcium and/or magnesium are referred to as salts. Calcium and magnesium salts are often found in ground water supplies and cause "hardness" in water. Hard and soft water are relative terms. Hard water retards the cleaning action of soaps and detergents, causing expense in the form of extra work and cleaning agents. When hard water is heated, it will deposit a hard scale. With regard to air bathtubs, high calcium and/or magnesium levels may result in the formation of white stains and scale formation on the inside of the tubs, especially noticeable with colored tubs. If this occurs, you need to contact the water supplier to determine the calcium and/or magnesium content and/or corrosion potential of the water and follow their suggestions for treatment. If you are on an individual well, you need to contact a water treatment company to test your water and suggest solutions if a problem is present.

**Iron** - Iron is found in many natural waters especially from wells. Iron in water can also result from the corrosion of piping in the water supply system, such as cast iron mains or galvanized steel service lines, or galvanized piping in the home water system. High iron levels may result in the formation of brown stains in the vicinity of the faucet outlets of various fixtures in the home. With air bathtubs, the staining may be particularly pronounced because the aeration

# WATER QUALITY

action can oxidize iron to a form that settles out on the inside of the tubs, especially noticeable with white tubs. If high iron in the water is present, you can also notice rust colored deposits inside your toilet tank or dishwasher. If this occurs, you need to contact the water supplier to determine the iron content and/or corrosion potential of the water and follow their suggestions for treatment. If you are on an individual well you need to contact the water treatment company to test your water and suggest solutions if a problem is present.

**Manganese** - Manganese is found in many natural waters especially from wells. High manganese levels may result in the formation of small black particles that can stain laundry, especially noticeable with whites such as sheets or towels. With air bathtubs, the formation of small black particles may be particularly pronounced because the aeration action in the tub can oxidize manganese to an insoluble form that is especially noticeable with white tubs. If high manganese in the water is present, you may also notice black stains on white laundry. If this occurs, you need to contact the water supplier to determine the manganese content of the water and follow their suggestions for treatment. If you are on an individual well, you need to contact a water treatment company to test your water and suggest solutions if a problem is present.

### 3. Treatment

If you have contacted your water supplier and followed their instructions and you are still having problems, you need to increase the frequency of applications of low-foaming detergent/bleach starting from monthly purging down to using it every other day as required to eliminate your particular problem. The use of certain bath oils, bubble bath soaps and bath additives may increase the level of accumulations of bath residue in the air system. More frequent cleaning may be necessary if these products are used in the air tub. If excess accumulations persist, you should discontinue the use of these products. If you have followed the monthly purging instructions and still have an excess accumulation of bath residue and desire an alternative cleaning mechanism, we recommend **SUPER SYSTEMS CLEAN PLUS** (Aquatic part #ST1010) manufactured by Stearns Packaging Corporation to rectify this condition. This may be obtained by contacting Aquatic at (800) 945-2726. It is recommended that you follow the instructions provided by the manufacturer with the product. Repeated use may be necessary. **SUPER SYSTEMS CLEAN PLUS** does not replace the necessity to purge your air system at least once a month with a low foaming detergent and bleach.



# TROUBLESHOOTING GUIDE

**WARNING:** Always turn off power at the main electrical service panel when servicing your air-whirlpool.

SYMPTOMS	POSSIBLE PROBLEMS	SUGGESTED SOLUTIONS
Motor does not start	<ol style="list-style-type: none"> <li>1) GFCI or circuit breaker in OFF position.</li> <li>2) Fuses blown or thermal overload open.</li> <li>3) Locked motor shaft.</li> <li>4) Motor windings burned out.</li> <li>5) Defective starting switch inside single-phase motor.</li> <li>6) Disconnected or defective wiring.</li> <li>7) Low voltage.</li> </ol>	<ol style="list-style-type: none"> <li>1) Reset GFCI.</li> <li>2) Contact your electrician.</li> <li>3) Contact Aquatic.</li> <li>4) Contact Aquatic.</li> <li>5) Contact Aquatic.</li> <li>6) Check and reconnect if needed.</li> <li>7) Contact your electrician.</li> </ol>
Motor does not reach full speed	<ol style="list-style-type: none"> <li>1) Low voltage.</li> <li>2) Wiring too small.</li> </ol>	<ol style="list-style-type: none"> <li>1) Contact your electrician.</li> <li>2) Contact your electrician.</li> </ol>
Motor overheats (protector trips)	<ol style="list-style-type: none"> <li>1) Low voltage.</li> <li>2) Inadequate ventilation.</li> <li>3) Wiring too small.</li> </ol>	<ol style="list-style-type: none"> <li>1) Contact your electrician.</li> <li>2) Refer to installer/dealer.</li> <li>3) Contact your electrician.</li> </ol>
Pump delivers no water	<ol style="list-style-type: none"> <li>1) Jets are closed.</li> <li>2) Leakage of air into suction system.</li> <li>3) Impeller clogged.</li> </ol>	<ol style="list-style-type: none"> <li>1) Open jets.</li> <li>2) Check suction screen for clogs.</li> <li>3) Clean and unplug.</li> </ol>
Low pump capacity	<ol style="list-style-type: none"> <li>1) Suction or discharge line partly plugged.</li> <li>2) Pump running at reduced speed.</li> <li>3) Impeller clogged.</li> </ol>	<ol style="list-style-type: none"> <li>1) Clean and unplug.</li> <li>2) See "Motor does not reach full speed."</li> <li>3) Clean and unplug.</li> </ol>
Noisy pump and motor	<ol style="list-style-type: none"> <li>1) Worn motor bearings.</li> <li>2) Pumps touching a stationary object.</li> <li>3) Suction line partly plugged.</li> <li>4) Pump not supported properly.</li> <li>5) Low voltage.</li> </ol>	<ol style="list-style-type: none"> <li>1) Contact Aquatic.</li> <li>2) Refer to installer/dealer.</li> <li>3) Clean and unplug.</li> <li>4) Contact Aquatic. (If you have a remote pump, refer to installer/dealer.)</li> <li>5) Contact electrician.</li> </ol>
Leakage of water at shaft	<ol style="list-style-type: none"> <li>1) Shaft seal requires replacement.</li> </ol>	<ol style="list-style-type: none"> <li>1) Contact Aquatic.</li> </ol>
Leaking unions	<ol style="list-style-type: none"> <li>1) O-ring missing or damaged.</li> <li>2) Plumbing in a bind.</li> <li>3) Loose unions.</li> </ol>	<ol style="list-style-type: none"> <li>1) Contact Aquatic.</li> <li>2) Contact Aquatic.</li> <li>3) Tighten unions.</li> </ol>
Vibration noise	<ol style="list-style-type: none"> <li>1) Tub or tub plumbing is touching tile/wall.</li> <li>2) Pump is touching framing.</li> </ol>	<ol style="list-style-type: none"> <li>1) Refer to installer/dealer.</li> <li>2) Refer to installer/dealer.</li> </ol>
Air Bath system does not operate	<ol style="list-style-type: none"> <li>1) No power to air blower.</li> <li>2) Blower is not plugged in.</li> <li>3) Control Panel connector to blower is disconnected.</li> </ol>	<ol style="list-style-type: none"> <li>1) Reset circuit breakers and GFCI if tripped. Check fuses and replace if bad.</li> <li>2) Make sure plug is fully inserted into the outlet.</li> <li>3) Check and reconnect if needed.</li> </ol>
Blower turns off by itself or before time elapses	<ol style="list-style-type: none"> <li>1) Blower motor overheated and thermal protection device deactivated motor (possibly low voltage).</li> <li>2) GFCI tripped.</li> </ol>	<ol style="list-style-type: none"> <li>1) Check that blower has sufficient ventilation, and that the intake to the blower is not blocked, clear and allow motor to cool down. (Check service &amp; wire size.)</li> <li>2) Refer to installer/dealer.</li> </ol>
Circuit breaker trips repeatedly	<ol style="list-style-type: none"> <li>1) Defective breaker.</li> <li>2) Short circuit between bath and breaker box.</li> <li>3) Other times are connected to the same circuit.</li> </ol>	<ol style="list-style-type: none"> <li>1) Change out breaker.</li> <li>2) Refer to installer/dealer.</li> <li>3) Refer to installer/dealer.</li> </ol>
Blower does not manually shut off	<ol style="list-style-type: none"> <li>1) Defective control panel.</li> <li>2) Defective blower.</li> </ol>	<ol style="list-style-type: none"> <li>1) Refer to installer/dealer. Replace control panel.</li> <li>2) Refer to installer/dealer. Replace blower.</li> </ol>
Air blower does not function properly while in the pulse or wave modes	<ol style="list-style-type: none"> <li>1) Speed of air setting is set too low.</li> </ol>	<ol style="list-style-type: none"> <li>1) Change the air speed setting to a mid-range setting before switching to wave or pulse modes.</li> </ol>

# REPLACEMENT PARTS LIST

ILLUSTRATION NO.	PART #	DESCRIPTION
1A.	8186ASSYxx	FULL SIZE DIRECTIONAL JET
1B.	8186VJTB	VJET BODY
	8186BDY	90 DEGREE JET BODY
	8186WFTG	WALL FITTING
2A..	8184ROTxx	STRESSEAZ JET INTERNAL
2B.	8184JTB	STRESSEAZ JET BODY
2C.	8180NUT	JET NUT
3A.	8180ROTxx	ROTATIONAL SWIRL JET
3B.	8180JTB	ROTATIONAL SWIRL JET BODY
3C.	8180NUT	JET NUT
4A.	1126xx	SUCTION COVER
4B.	–	SUCTION WALL FITTING
4C.	–	SUCTION ELBOW
5	8441FTG+5982MANIFOLD	1" CHECK VALVE ASSEMBLY
6A.	8165KEYPAD	KEYPAD;BDL;LUXEAIR RECTANGLE (CHROMATHERAPY)
6A.	8167KEYPAD	KEYPAD;BDL;LUXEAIR OVAL (CHROMATHERAPY)
6B.	8166KEYPAD	KEYPAD;BDL;LUXEAIR RECTANGLE (CHROMATHERAPY)
6B.	8168KEYPAD	KEYPAD;BDL;LUXEAIR OVAL (CHROMATHERAPY)
7	8095HEATER	1.5 KW MAINTENENCE HEATER
8A.	8108MOTOR	1.75HP /120V PUMP
8B.	8150UNION	1.5" PUMP UNION
9A.	8750BLW	BLOWER;750W;VARIABLE; 120V;HEATER
9B.	1137	6' KEYPAD CABLE
10A. (OPTION)	8130BOX	CHROMATHERAPY CONTROL BOX (LUXEAIR+SERENITY)
10B. (OPTION)	8020LIGHTS	CHROMATHERAPY;20LEDS BULB;RND CLR
10C. (OPTION)	8LIGHTTOOL	LENS REMOVAL TOOL
10D. (OPTION)	8020LIGHTS	20LEDS CHROMATHERAPY BULB
11	8160BOX	CONTROL BOX;TMS;W/P ON/OFF CNFG;120V

# REPLACEMENT PARTS MAP

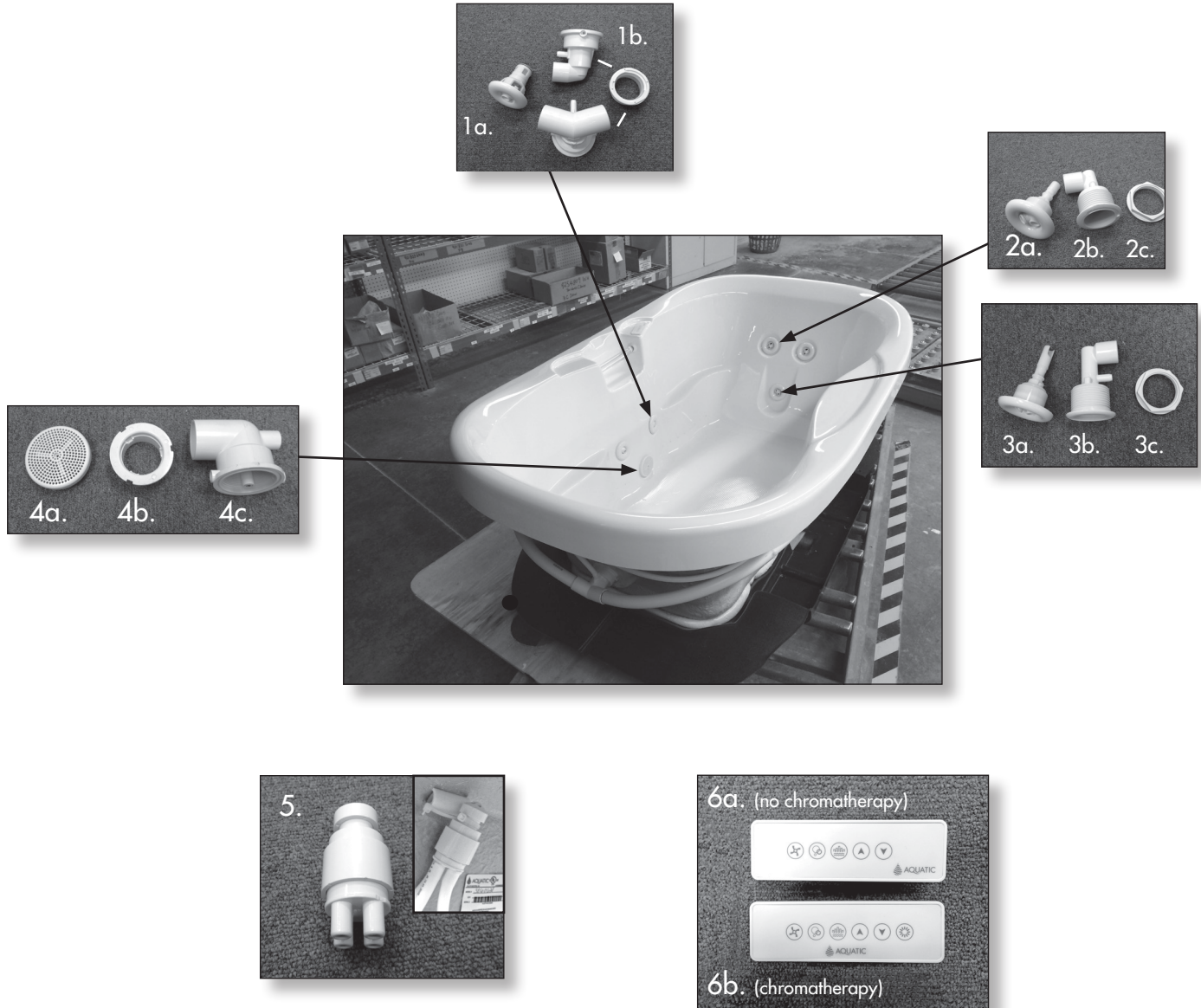

# REPLACEMENT PARTS MAP

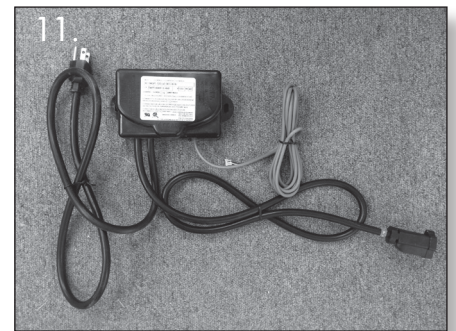
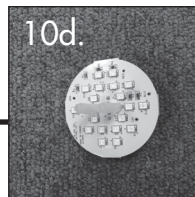
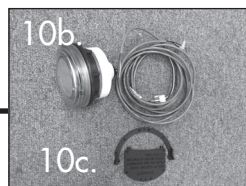
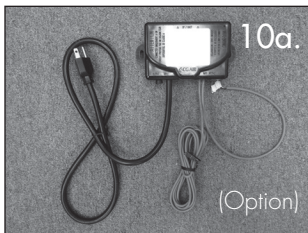
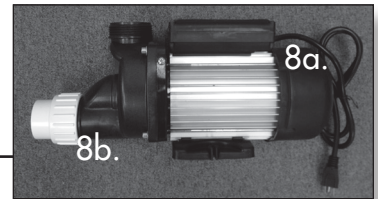
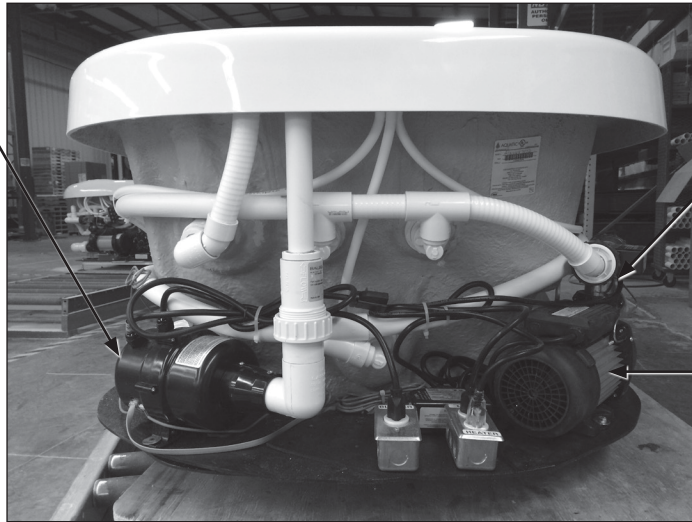
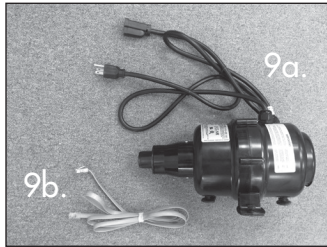





**AQUATIC**

The bath people

Customer Service: 800.945.2726 • [aquaticbath.com](http://aquaticbath.com)